

K58

Specifications 1/6

Incremental Type (Hollow shaft、through hole)

- Feature: Thin type, sturdy and durable, optional various output mode, easy to install
- Application: textile industry, motor, packing machinery, production line, etc, for automation control
- External dimensions: external diameter $\varnothing 58\text{mm}$, thickness 24mm, diameter of shaft $\varnothing 15\text{mm}; \varnothing 16\text{mm}; \varnothing 18\text{mm}; \varnothing 20\text{mm}; \varnothing 22\text{mm}$ (optional)
- Resolution: up to 28800P/R
- Supply voltage: DC5V; DC8-30V
- Protection: IP50
- Cable length: 1000mm
- Weight: about 150g

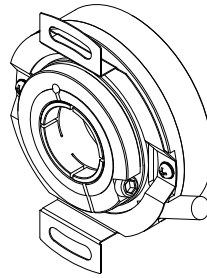

K58-J
(Clamping ring at prior)

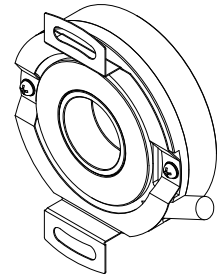

K58-J
(Clamping ring at rear)

Model Guide

- Model form (filled required parameters in the box as following)
- Must choose supply voltage: DC5V; DC8-30V
- Must choose clamping ring at prior (BQ) or clamping ring at rear (B) when choosing diameter of shaft
- Leaf spring (pls refer to specification on page 6/6)

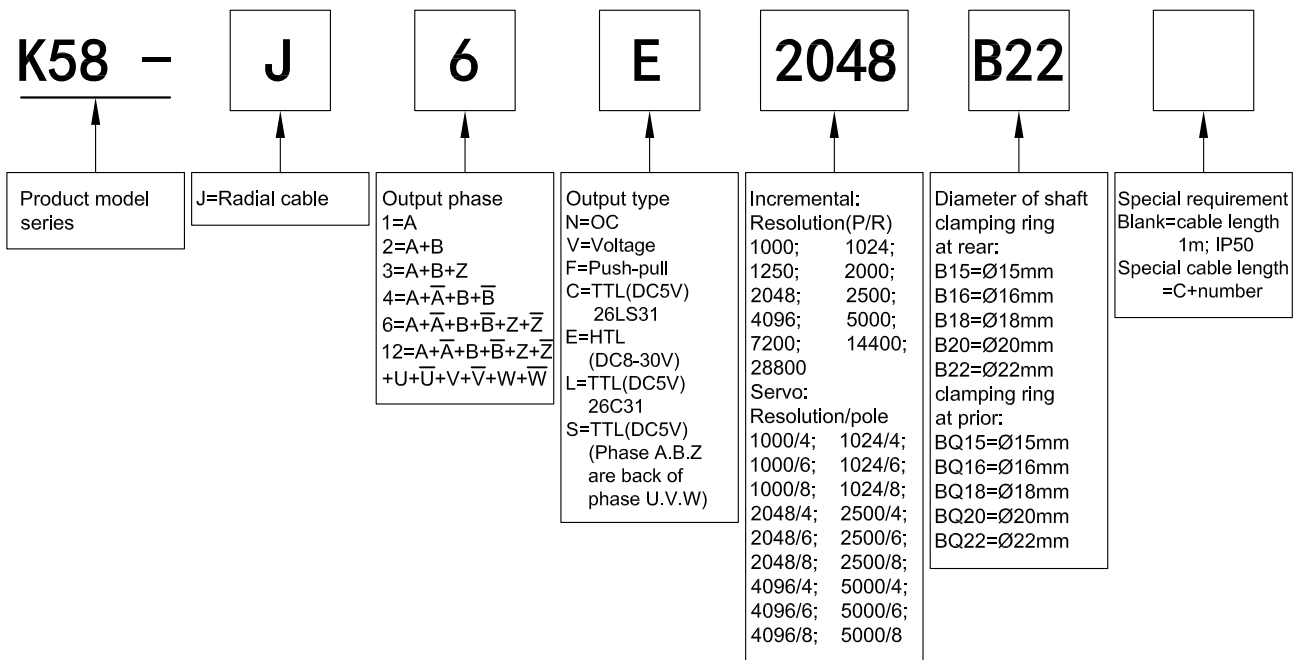

K58 Specifications 2/6

Output Mode

Output type	Output circuit	Output wave form	Connection
OC		<p> $a.b.c.d = \frac{T}{4} \pm \frac{T}{8}$ Phase A is ahead of B by $\frac{T}{4} \pm \frac{T}{8}$, rotation direction CW (Viewing from shaft end, direction is clockwise rotation) CW direction \rightarrow </p>	0=GND 1=red=DC5V; DC8-30V 2=black=OV 3=white=A 4=green=B 5=yellow=Z
Push-Pull		<p> $a.b.c.d = \frac{T}{4} \pm \frac{T}{8}$ Phase A is ahead of B by $\frac{T}{4} \pm \frac{T}{8}$, rotation direction CW (Viewing from shaft end, direction is clockwise rotation) CW direction \rightarrow </p>	
Voltage		<p> $a.b.c.d = \frac{T}{4} \pm \frac{T}{8}$ Phase A is ahead of B by $\frac{T}{4} \pm \frac{T}{8}$, rotation direction CW (Viewing from shaft end, direction is clockwise rotation) CW direction \rightarrow </p>	
TTL HTL		<p> $a.b.c.d = \frac{T}{4} \pm \frac{T}{8}$ Phase A is ahead of B by $\frac{T}{4} \pm \frac{T}{8}$, rotation direction CW (Viewing from shaft end, direction is clockwise rotation) CW direction \rightarrow </p>	

K58

Specifications 3/6

● Output Mode

Output type	Output circuit	Output wave form	Connection																																																																	
TTL		<p> $a, b, c, d = \frac{T}{4} \pm \frac{T}{8}$ $e = T \pm \frac{T}{2}$ f: center of phase Z to rise point of phase U, that is $\pm 0.3^\circ$ </p> <p>CCW direction \rightarrow (Viewed from shaft end when installing)</p> <p>A.B.Z.U.V.W $\bar{A}, \bar{B}, \bar{Z}, \bar{U}, \bar{V}, \bar{W}$</p>	0=shielding=GND 1=red=DC5V 2=black=OV 3=white=A 4=green=B 5=yellow=Z 6=white/black= \bar{A} 7=green/black= \bar{B} 8=yellow/black= \bar{Z} 9=blue=U 10=grey=V 11=pink=W 12=blue/black= \bar{U} 13=grey/black= \bar{V} 14=pink/black= \bar{W}																																																																	
TTL (phase A.B.Z are back of phase U.V.W)	<table border="1"> <thead> <tr> <th>pole</th> <th>g, h, j, k, m, n</th> <th>r</th> </tr> </thead> <tbody> <tr> <td>4</td> <td>$30 \pm 1^\circ$</td> <td>180°</td> </tr> <tr> <td>6</td> <td>$20 \pm 1^\circ$</td> <td>120°</td> </tr> <tr> <td>8</td> <td>$15 \pm 1^\circ$</td> <td>90°</td> </tr> </tbody> </table>	pole	g, h, j, k, m, n	r	4	$30 \pm 1^\circ$	180°	6	$20 \pm 1^\circ$	120°	8	$15 \pm 1^\circ$	90°	<p> $a, b, c, d = \frac{T}{4} \pm \frac{T}{8}$ $e = T \pm \frac{T}{2}$ f: center of phase Z to rise point of phase U, that is $\pm 0.3^\circ$ </p> <p>CCW direction \rightarrow (Viewed from shaft end when installing)</p> <p>A.B.Z.U.V.W $\bar{A}, \bar{B}, \bar{Z}, \bar{U}, \bar{V}, \bar{W}$</p>	<table border="1"> <thead> <tr> <th rowspan="2">No.</th> <th rowspan="2">Function Color</th> <th colspan="3">Mode</th> </tr> <tr> <th>1</th> <th>2</th> <th>3</th> </tr> </thead> <tbody> <tr> <td>3</td> <td>white</td> <td>HZ</td> <td>U</td> <td>A</td> </tr> <tr> <td>6</td> <td>white/black</td> <td>HZ</td> <td>\bar{U}</td> <td>\bar{A}</td> </tr> <tr> <td>4</td> <td>green</td> <td>HZ</td> <td>V</td> <td>B</td> </tr> <tr> <td>7</td> <td>green/black</td> <td>HZ</td> <td>\bar{V}</td> <td>\bar{B}</td> </tr> <tr> <td>5</td> <td>yellow</td> <td>HZ</td> <td>W</td> <td>Z</td> </tr> <tr> <td>8</td> <td>yellow/black</td> <td>HZ</td> <td>\bar{W}</td> <td>\bar{Z}</td> </tr> <tr> <td>1</td> <td>red</td> <td colspan="3">DC+5V</td> </tr> <tr> <td>2</td> <td>black</td> <td colspan="3">OV</td> </tr> <tr> <td>0</td> <td>shielding</td> <td colspan="3">GND</td> </tr> </tbody> </table>	No.	Function Color	Mode			1	2	3	3	white	HZ	U	A	6	white/black	HZ	\bar{U}	\bar{A}	4	green	HZ	V	B	7	green/black	HZ	\bar{V}	\bar{B}	5	yellow	HZ	W	Z	8	yellow/black	HZ	\bar{W}	\bar{Z}	1	red	DC+5V			2	black	OV			0	shielding	GND		
pole	g, h, j, k, m, n	r																																																																		
4	$30 \pm 1^\circ$	180°																																																																		
6	$20 \pm 1^\circ$	120°																																																																		
8	$15 \pm 1^\circ$	90°																																																																		
No.	Function Color	Mode																																																																		
		1	2	3																																																																
3	white	HZ	U	A																																																																
6	white/black	HZ	\bar{U}	\bar{A}																																																																
4	green	HZ	V	B																																																																
7	green/black	HZ	\bar{V}	\bar{B}																																																																
5	yellow	HZ	W	Z																																																																
8	yellow/black	HZ	\bar{W}	\bar{Z}																																																																
1	red	DC+5V																																																																		
2	black	OV																																																																		
0	shielding	GND																																																																		
<p>Timing Chart</p> <p> Supply voltage: 5 ± 0.25, 4.25 ± 0.3 Instantaneous power down Power off Power on Time(msec) Mode: 1, 2, 3 35MIN, 7\pm2, 510\pm220, 22\pm11 </p> <p> Symbol signification ★: indicate position of UVW channel ☆: position to start counting ABZ channel □: non-using zone HZ: high impedance </p>																																																																				

K58

Specifications 4/6

■ Electrical Characteristics

Parameter Item	Output type	OC		Voltage		Push-pull		TTL(26LS31)	TTL(26C31)	TTL(26C31) (Phase A,B,Z are back of phase U,V,W)	HTL(HD7)
		Supply voltage		DC+5V±5% & DC8V-30V±5%						DC+5V±5%	
Consumption current		100mA Max						120mA Max			
Allowable ripple		≤3%rms									
Top response frequency		100KHz						200KHz		300KHz	
Output capacity	Output current	Input	≤30mA	Load resistance 2.2K	≤30mA	≤±20mA		≤±50mA			
		Output	—		≤10mA						
	Output voltage	"H"	—	—	≥[(Supply voltage) -2.5V]	≥2.5V		≥V _{CC} -3 V _{DC}			
		"L"	≤0.4V	≤0.7V(less than 20mA)	≤0.4V(30mA)	≤0.5V		≤ 1V V _{DC}			
Load voltage	≤DC30V		—		—						
Rise & Fall time		Less than 2us(cable length: 2m)				Less than 1us(Cable length: 2m)		≤100ns			
Insulation strength		AC500V 60s									
Insulation resistance		10MΩ									
Mark to space ratio		45% to 55%									
Phase shift between A & B		90°±10° (frequency in low speed)									
		90°±20° (frequency in high speed)									
Origin motion		Low level available	High level available	Low level available	—		Low level available	—			
Delay motion time *		—						510±220ms	—		
GND		not connect to encoder									

* Phase A,B,Z are back of phase U,V,W when power on.

■ Mechanical Characteristics

Shaft	Ø15mm; Ø16mm; Ø18mm; Ø20mm; Ø22mm(stainless steel)
Starting torque	Less than 9.8×10^{-3} N·m
Inertia moment	Less than 6.5×10^{-6} kg·m ²
Shaft load	Radial 50N; Axial 30N
Slew speed	≤3000 rpm
Bearing Life	1.5X10 ⁹ revs at rated load(100000hrs at 2500RPM)
Shell	Die cast aluminum
Weight	about 150g

■ Environmental Specifications

Environmental temperature	Operating: -20~+85°C(repeatable winding cable; -10°C); Storage: -25~+90°C
Environmental humidity	Operating and storage: 35~85%RH(noncondensing)
Vibration(endure)	Amplitude 1.52mm,5~55Hz,2h for X,Y,Z direction individually
Shock(endure)	980m/s ² 11ms three times for X,Y,Z direction individually
Protection	IP50

K58 Specifications 5/6

Basic Dimensions

- Clamping ring at prior(BQ)

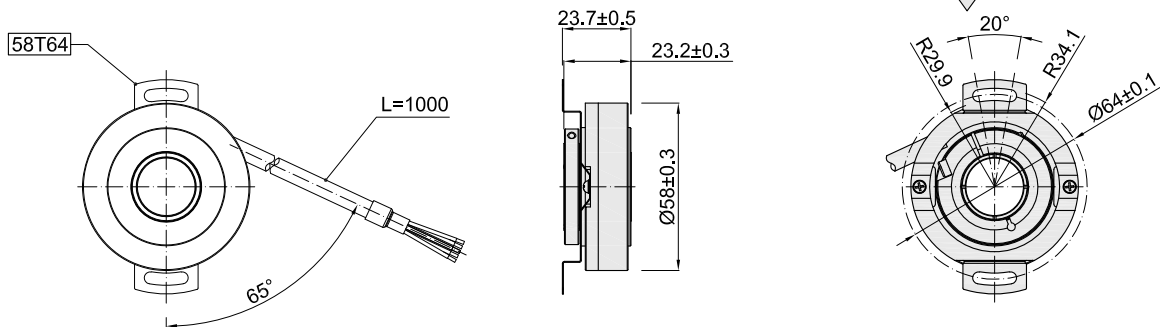

- Clamping ring at rear(B)

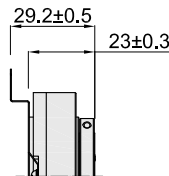

Assembling requirement

- Clamping ring at prior(BQ)

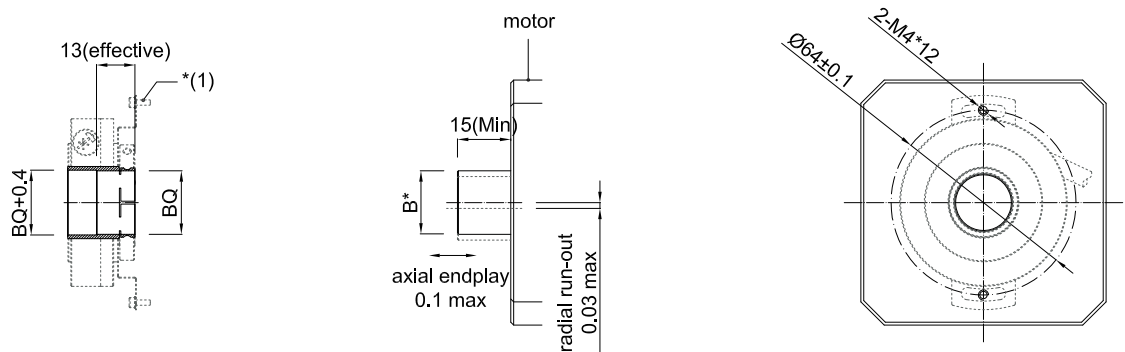

- Clamping ring at rear(B)

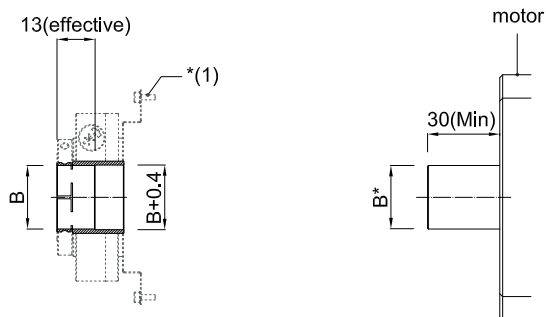

BQ	B	B*
Ø15 ^{G7} _{g6} (+0.024/+0.006)	Ø15 ^{G7} _{g6} (-0.006/-0.017)	Ø15 ^{G7} _{g6} (-0.006/-0.017)
Ø16 ^{G7} _{g6} (+0.024/+0.006)	Ø16 ^{G7} _{g6} (-0.006/-0.017)	Ø16 ^{G7} _{g6} (-0.006/-0.017)
Ø18 ^{G7} _{g6} (+0.028/+0.007)	Ø18 ^{G7} _{g6} (-0.006/-0.017)	Ø18 ^{G7} _{g6} (-0.006/-0.017)
Ø20 ^{G7} _{g6} (+0.028/+0.007)	Ø20 ^{G7} _{g6} (-0.007/-0.020)	Ø20 ^{G7} _{g6} (-0.007/-0.020)
Ø22 ^{G7} _{g6} (+0.028/+0.007)	Ø22 ^{G7} _{g6} (-0.007/-0.020)	Ø22 ^{G7} _{g6} (-0.007/-0.020)

B* Motor shaft diameter tolerance

Unit: mm

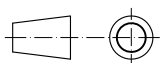

Note:

*(1): Inner hexagon screw M4*8 with flat gasket and spring ring is recommended to use

58T64 = Leaf Spring



= Rotate direction of incremental signal output shaft



= Rotate direction of servo signal output shaft

K58 Specifications 6/6

■ Accessory (Leaf spring)

<p>58T64 Standard</p>	
<p>58T80 purchase additionally</p> <p>The leaf spring can be mounted on the arched surface of the motor cover</p>	

Unit: mm

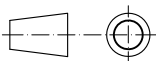

Note:

*(1): Clamping ring at prior(BQ)

*(2): Clamping ring at rear(B)

About vibration

Vibration act on encoder always cause wrong pulse ,so we should pay attention to working place. More pulse per revolution , narrower groovy spacing of grating ,more effect to encoder by vibration,when rev is low or stop , vibration act on shaft or main body would cause grating vibrating ,so encoder might make wrong pulse.