

PN48

Specifications 1/9

■ Incremental Type (Through shaft)

- Feature: PN48 has a mechanical soft connection structure, which is uniquely designed with photoelectric induction and ultra-thin overall. With an LED to indicate the zero position of the encoder, it's also easy to install and debug, various of shaft holes available, dust-proof protection, and can solve problems for encoders in high runout motor shaft and installation in limited spaces.
- Application: servo motor, robot etc .
- External dimensions: external diameter 48mm, thickness 14mm, hollow shaft up to Ø14mm
- Induction type: photoelectric
- Resolution: up to 10000P/R
- Supply voltage: DC5V; DC8-30V
- Protection: IP50
- Radial connector: E=SM08B-GHS-TB;
F=SM14B-GHS-TB
- Radial cable: cable length 1 meter (standard)
- Weight: about 80g

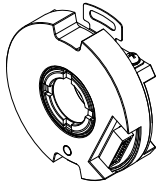

PN48-E

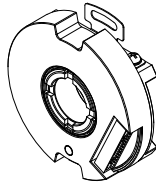

PN48-F

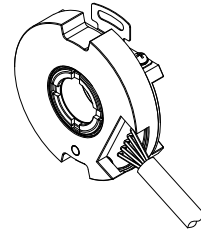

PN48-J

■ Model Guide

- Model form (filled required parameters in the blank as following)

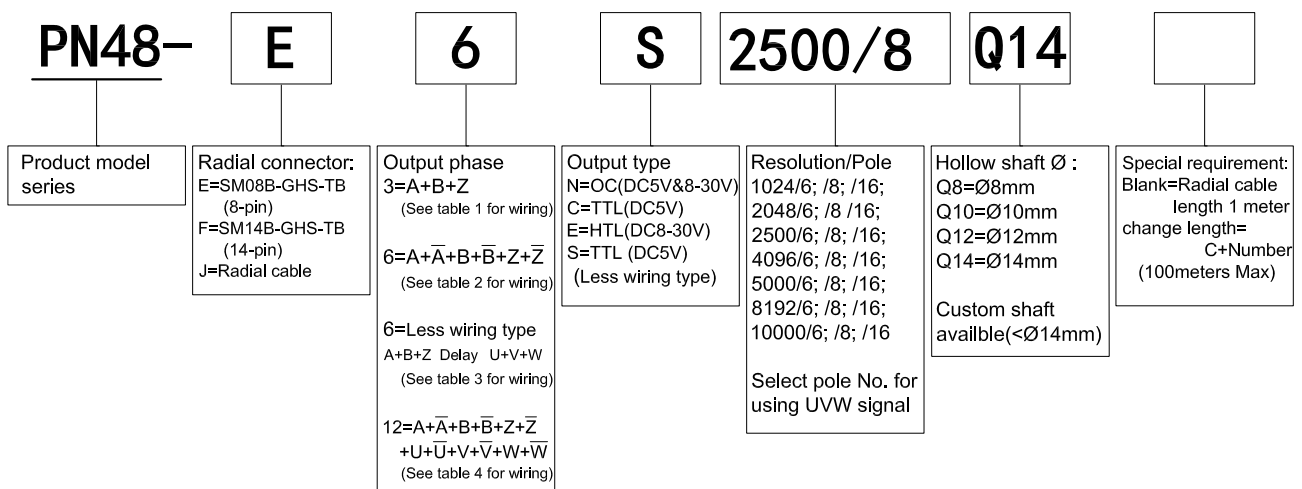

PN48

Specifications 2/9

Output Mode

Output type	Output circuit	Output wave form												
OC (DC5V & 8-30V)		<p> $a, b, c, d = \frac{T}{4} \pm \frac{T}{8}$ A phase is $\frac{1}{4}T \pm \frac{1}{8}T$ ahead of B phase (Viewed from front side) CCW direction </p>												
TTL(DC5V) HTL(DC8-30V)		<p> $a, b, c, d = \frac{T}{4} \pm \frac{T}{8}$ $e = T \pm \frac{T}{2}$ f: Phase shift from center of Z phase to rise of U phase: $\pm 0.5^\circ$ (Viewed from front side) CW direction </p>												
TTL (DC5V) (Less wiring type) A.B.Z delay U.V.W		<table border="1"> <thead> <tr> <th>poles</th> <th>g,h,j,k,m,n</th> <th>r</th> </tr> </thead> <tbody> <tr> <td>6</td> <td>$20 \pm 1^\circ$</td> <td>120°</td> </tr> <tr> <td>8</td> <td>$15 \pm 1^\circ$</td> <td>90°</td> </tr> <tr> <td>16</td> <td>$7.5 \pm 1^\circ$</td> <td>45°</td> </tr> </tbody> </table>	poles	g,h,j,k,m,n	r	6	$20 \pm 1^\circ$	120°	8	$15 \pm 1^\circ$	90°	16	$7.5 \pm 1^\circ$	45°
poles	g,h,j,k,m,n	r												
6	$20 \pm 1^\circ$	120°												
8	$15 \pm 1^\circ$	90°												
16	$7.5 \pm 1^\circ$	45°												

Timing Chart

Mode	1	2	3
1	510±220	22±11	
2	510±220	22±11	
3		22±11	510±220

Symbolic meaning

- ★: Position for latching UVW phases
- ☆: Position to start counting ABZ phases
- ⊠: Non-using zones
- HZ: High Resistance

No.	Mode		
	1	2	3
1	HZ	U	A
2	HZ	\bar{U}	\bar{A}
3	HZ	V	B
4	HZ	\bar{V}	\bar{B}
5	HZ	W	Z
6	HZ	\bar{W}	\bar{Z}
7	DC+5V		
8	OV		

■ Electrical Specifications

Parameter Item	Output type		OC	TTL	TTL (Less wiring type)	HTL
Supply voltage			DC5V & 8-30±5%	DC+5V±5%		DC8-30V±5%
Consumption current			120mA Max			
Top response frequency			100KHz	500KHz		800KHz
Output capacity	Output current		≤±30mA	≤±20mA		≤±50mA
	Output voltage	"H"	—	≥2.5V		≥V _{cc} -3 V _{DC}
		"L"	≤0.4V	≤0.5V		≤ 1V V _{DC}
Rise. Fall time			Less than 1us(cable length: 2m)			
Delay motion time *			—		510±220ms	—
Shielding			not connected to the encoder, must be effectively connected to GND			

* Delayed time for A.B.Z delay U.V.W when power on.

■ Mechanical Specifications

Hollow shaft Ø	Ø8mm; Ø10mm; Ø12mm; Ø14mm(optional)
Starting torque	Less than 9.8×10^{-3} N·m
Inertia moment	Less than 6.5×10^{-6} kg·m ²
Shaft load	Radial 30N; Axial 20N
Slew speed	≤10000 rpm
Shell	Aluminium alloy
Weight	About 80g

■ Environmental Specifications

Environmental temperature	Operating: -20~+95°C; Storage: -25~+100°C
Environmental humidity	Operating and storage: 35~85%RH (noncondensing)
Protection	IP50

PN48

Specifications 4/9

■ Cable connection table



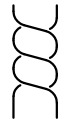
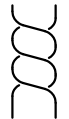
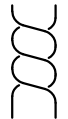
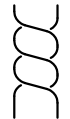

● Wiring table 1

Color	White	-	Green	-	Yellow	-	Red	Black
Pin No.	Pin1	Pin2	Pin3	Pin4	Pin5	Pin6	Pin7	Pin8
Function	A	-	B	-	Z	-	+DC	OV



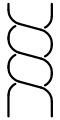

● Wiring table 2

Color	White	White/Black	Green	Green/Black	Yellow	Yellow/Black	Red	Black
Pin No.	Pin1	Pin2	Pin3	Pin4	Pin5	Pin6	Pin7	Pin8
Function	A	\bar{A}	B	\bar{B}	Z	\bar{Z}	+DC	OV
Twisted-paired cable								

● Wiring table 3 (Less wiring type)

Color	White	White/Black	Green	Green/Black	Yellow	Yellow/Black	Red	Black	
Pin No.	Pin1	Pin2	Pin3	Pin4	Pin5	Pin6	Pin7	Pin8	
Mode	1	HZ	HZ	HZ	HZ	HZ	+DC	OV	
	2	U	\bar{U}	V	\bar{V}	W			\bar{W}
	3	A	\bar{A}	B	\bar{B}	Z			\bar{Z}
Twisted-paired cable									

● Wiring table 4

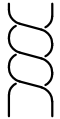
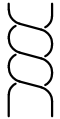
Color	Blue	Blue/Black	Gray	Gray/Black	Pink	Pink/Black	Yellow	Yellow/Black	Green	Green/Black	White	White/Black	Black	Red
Pin No.	Pin1	Pin2	Pin3	Pin4	Pin5	Pin6	Pin7	Pin8	Pin9	Pin10	Pin11	Pin12	Pin13	Pin14
Function	U	\bar{U}	V	\bar{V}	W	\bar{W}	Z	\bar{Z}	B	\bar{B}	A	\bar{A}	OV	+DC
Twisted-paired cable														

PN48 Specifications 5/9

■ Connector

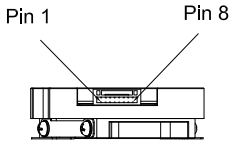
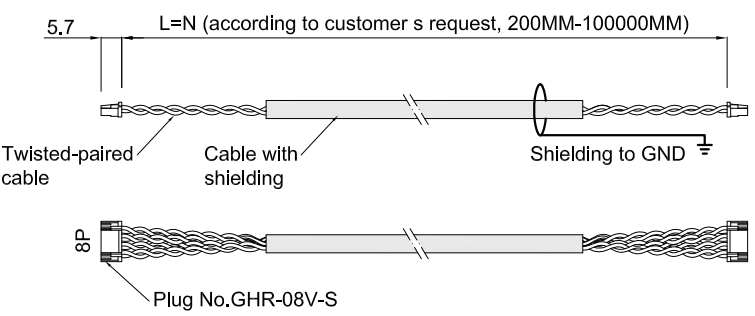
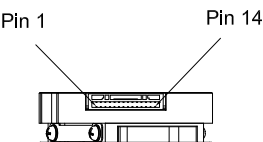
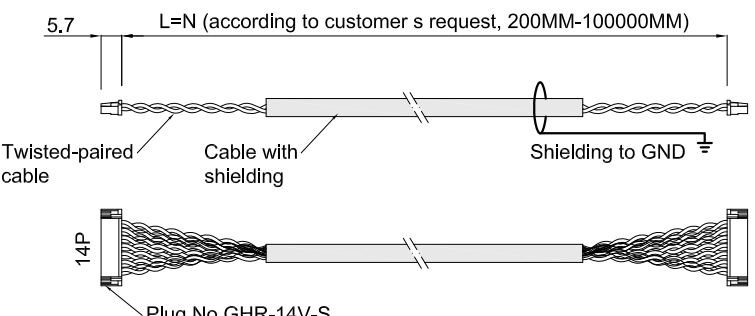
<p>Connector No. SM08B-GHS-TB</p> 	<p>Plug+shielding cable (order additionally)</p>  <p>5.7 L=N (according to customer s request, 200MM-10000MM)</p> <p>Twisted-paired cable Cable with shielding Shielding to GND</p> <p>8P Plug No.GHR-08V-S</p>
<p>Connector No. SM14B-GHS-TB</p> 	<p>Plug+shielding cable (order additionally)</p>  <p>5.7 L=N (according to customer s request, 200MM-10000MM)</p> <p>Twisted-paired cable Cable with shielding Shielding to GND</p> <p>14P Plug No.GHR-14V-S</p>

■ Radial Cable Schematic

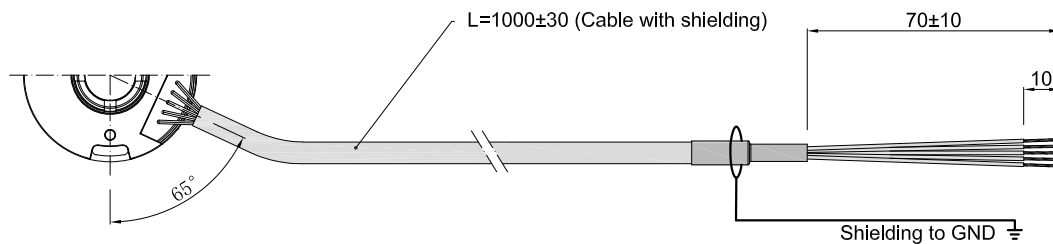

Unit: mm

PN48 Specifications 6/9

Basic Dimensions

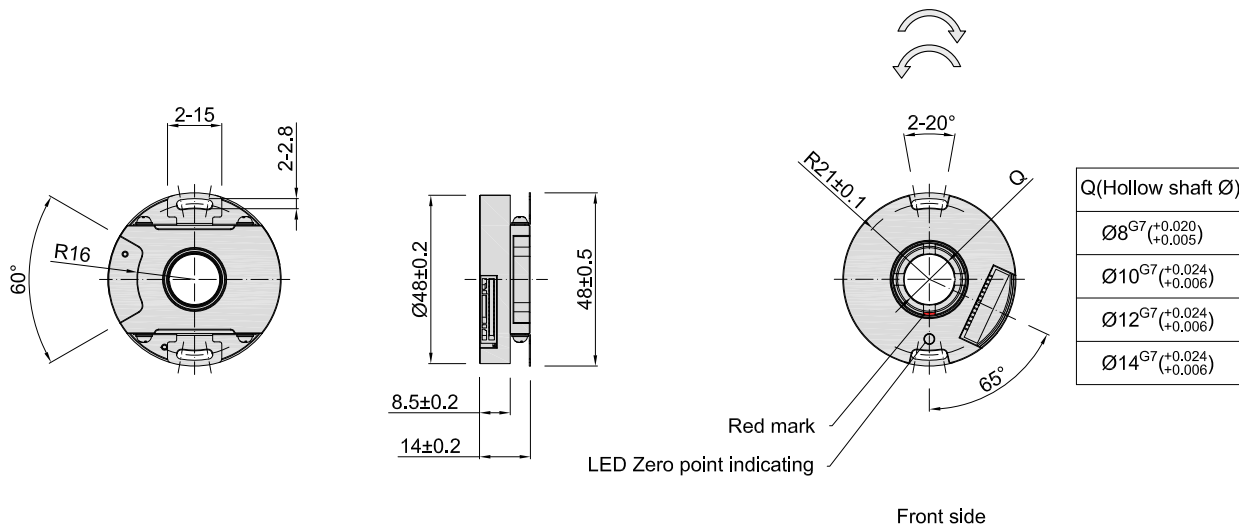

Specifications for Mounting shaft

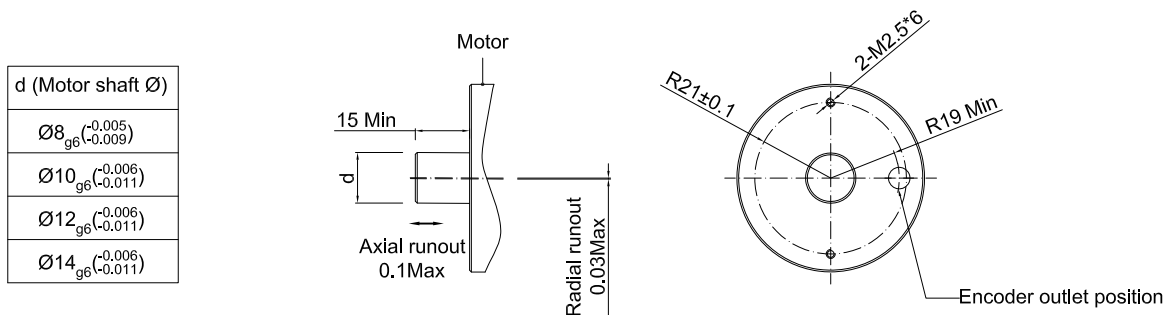

Unit: mm

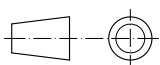

= Rotate direction of incremental TTL & HTL signal output shaft

= Rotate direction of OC signal output shaft

■ Assembling steps for encoder with UVW signal

Step 1

- Before installing the encoder, first to confirm the starting zero position of the motor and lock it tightly to ensure that the motor shaft is not moving until the encoder is finished installation, otherwise the encoder and the motor's zero position cannot be aligned.
- Put the encoder (2) directly on the motor shaft and gently push it to the motor platform by hand.
- Screwed the two M2.5*6 bolts (3) at the same time, but do not tighten, just enough to rotate the encoder by hand.

Note:

Please refer to page 6 for the matching tolerance of the encoder shaft sleeve and the motor shaft.

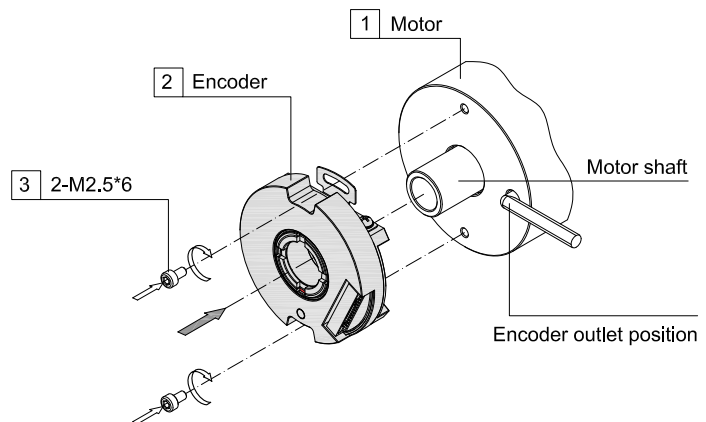

Step 2

- Fix the spanner (A) on the slot of the encoder shaft sleeve (outer ring) and then use the spanner (B) to tighten the lock nut (recommended tightening force is 10-13nm).
- Pls refer to the cable connection table on page 4-5, power on after checking all are correct, please confirm again that the motor is in the zero locked state, and then turn the encoder (2) left and right by hand, observe the LED on the encoder, when it is on, the zero signal is aligned, then tighten the two M2.5*6 bolts (3) and keep the LED on.

Note:

- *. The red mark on the shaft sleeve is always aligned with the LED indicator.
- *. After making sure that the lock nut has been tightened, put thread glue on the inner thread of the slot to prevent the screw from loosening.
- *. Because the width of the zero signal is relatively narrow, it is easy to cause displacement during the tightening process and the LED may not light up. please be patient to debug or use other testing equipments as auxiliary observation.

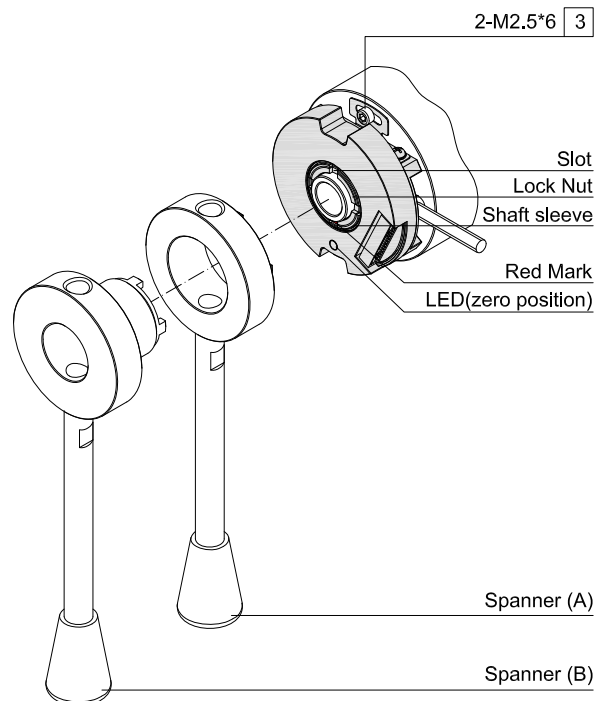

■ Assembling steps for encoder without UVW signal

Step 1

Put the encoder (2) directly on the motor shaft (1) and gently push it to the motor platform, then tighten the two M2.5*6 bolts (3) at the same time.

Note:

Please refer to page 6 for the matching tolerance of the encoder shaft sleeve and the motor shaft.

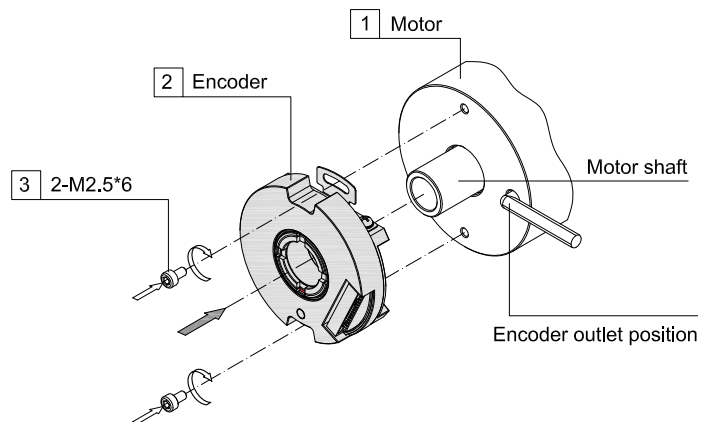

Step 2

Fix the spanner (A) on the slot of the encoder shaft sleeve (outer ring) and then use the spanner (B) to tighten the lock nut (recommended tightening force is 10-13nm).

Note:

- *. The red mark on the shaft sleeve aligned with the LED indicator is regarded as the zero primary position. when the LED light is on, this will be the final precise zero position.
- *. After making sure that the lock nut has been tightened, put thread glue on the inner thread of the slot to prevent the screw from loosening.

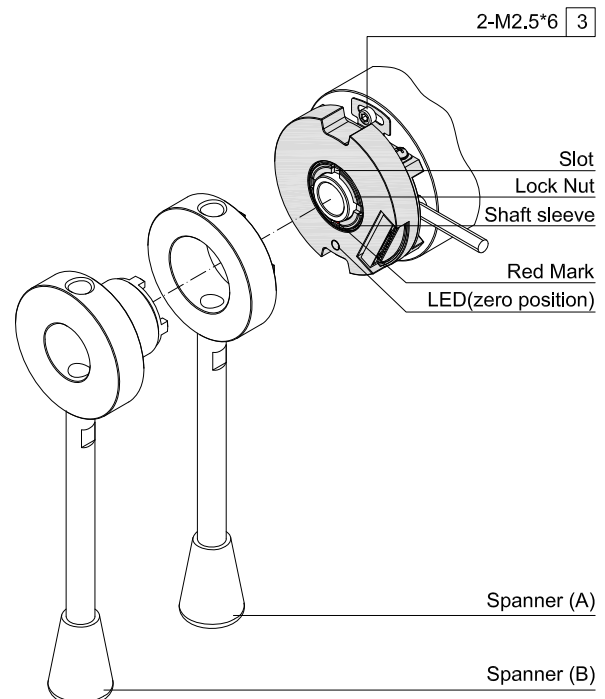

■ Caution

1. Caution for Operation

- The working temperature shall not exceed the storage temperature.
- The working humidity shall not exceed the storage humidity.
- Do not use where the temperature changes dramatically and have fog.
- Do not close to corrosive and flammable gas.
- Keep away from dust, salt and metal powder.
- Keep away from places where you will use water, oil, or medicine.
- Undue vibration and shock will impact the encoder.

2. Caution for Installation

- Please follow the installation steps in page 7-8
- Electrical components shall not be over-voltage or other phenomena. please conduct electrostatic assessment of the setting environment.
- Do not close the cable of the motor power to the encoder.
- The FG wire of the motor and mechanical device should be grounded.
- Perpendicularity between the motor mounting platform and the motor shaft must meet the requirements.
- The shielding wire must be effectively grounded since the shielding is not connected to the encoder.
- In order to keep the encoder stable against the electromagnetic insulation, the soft magnetic material (soft iron) is used as the encoder's outer cover, to prevent affecting from the external current magnetic field generated.

3. Caution for Wiring

- Use the encoder under the specified supply voltage. please note that the supply voltage range may drop due to the wiring length.
- Please do not put the encoder wires and other power lines in one pipe or binding together.
- Please use twisted pair wires for the signal and power wires of encoder.
- Please do not apply excessive force to the cable of encoder, or it will may be damaged.